

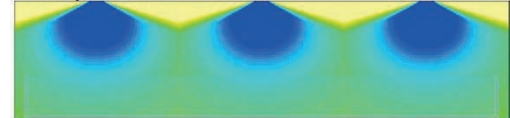

For further information
**please ask for
 our technical advise**

Blade angle modification
 in DVP-TR diffuser,
 with synchronized fins

Velocity - Elevation Section D



Temperature - Elevation Section D

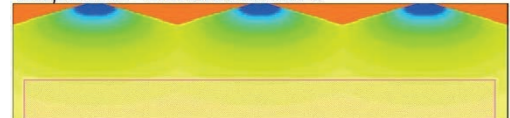

Velocity

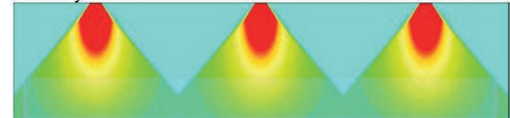

Temperature

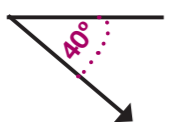
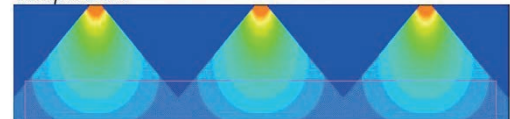

■ Totem diagram

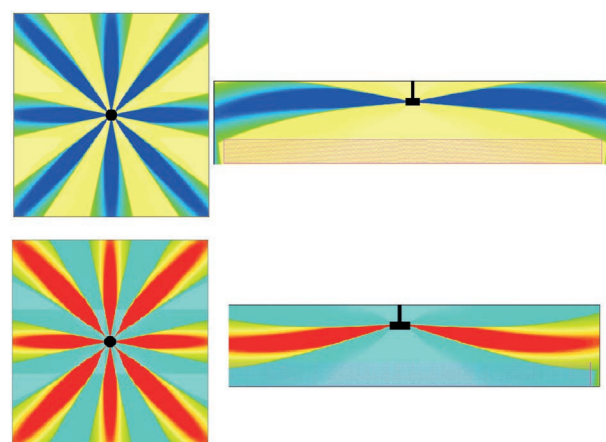

■ **BIM** Building Information Modelling

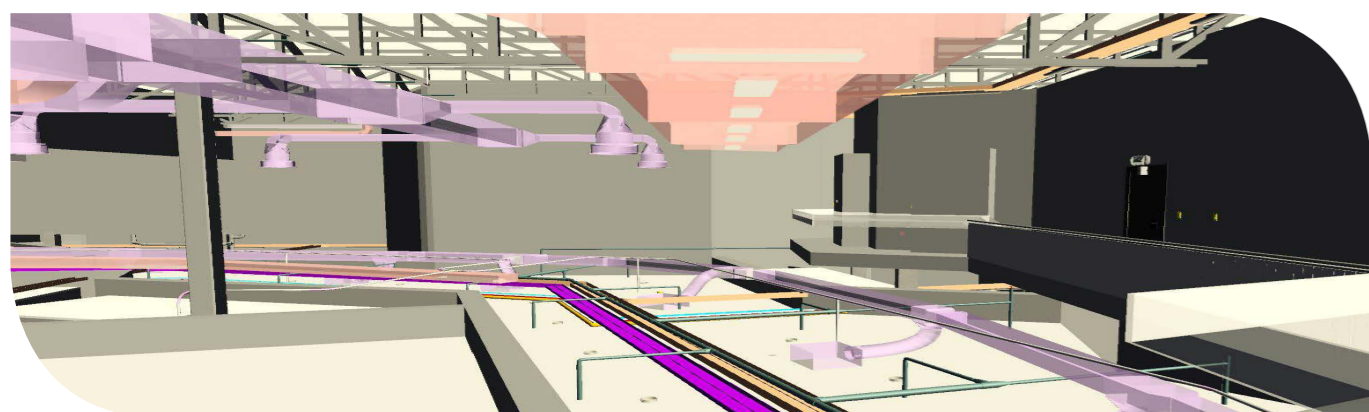

KOOLAIR

EXPERIENCE

IN ALL FIELDS



KOOLAIR

KOOLAIR, S.A. (España)
 Polig. Ind. Nº 2 – La Fuensanta
 28936 Móstoles (Madrid)
 Tel.: +34 91 645 00 33
 Fax: +34 91 645 69 62
 E-mail: info@koolair.com
www.koolair.com

Sectors

Koolair can adapt its product range to any ceiling types

Offices

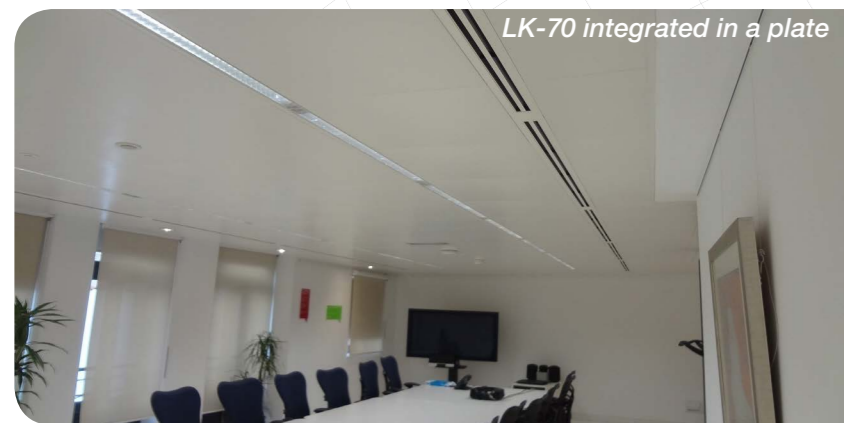

Healthcare



Industrial



Residential



Special features

Linear nozzle DF-47-NARROW

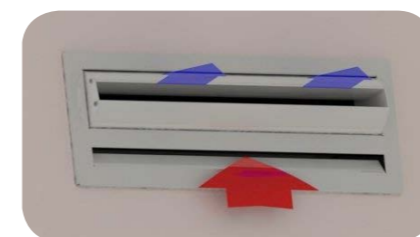
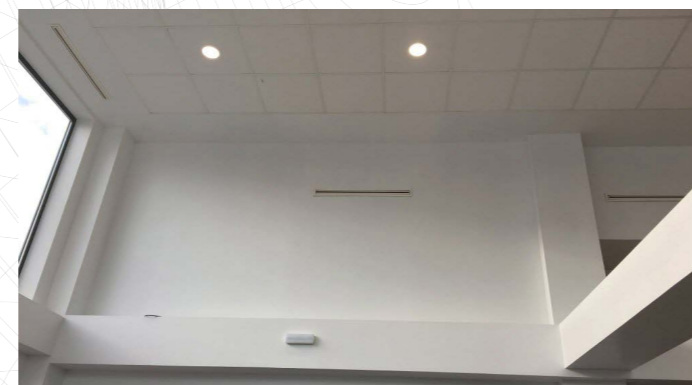

Thermo-adjustable circular diffuser DCL-TR



High induction diffuser DAI



Square diffuser KLD-Q-FLASH-LED

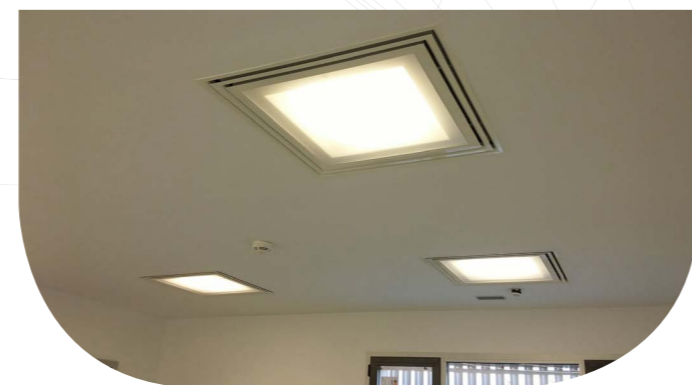

Constant air volume regulator KCRK



Fire protection

Fire dampers

Class EI-120 (ve i ↔ o) S, (ho i ↔ o) S and EI-180 (ho i ↔ o) S, (ve i ↔ o) S. Declared fire resistance performance for installation in wall, floor slab or flexible wall and test pressures up to 500 Pa. Models: SCFR-PD, SCFR-GD, SFR3K1GT, SCFC-PD and SCFC-GD

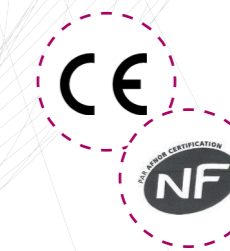
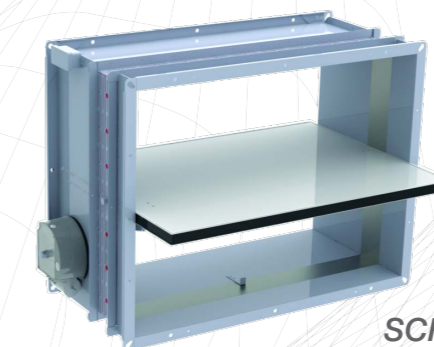

Butterfly fire dampers

Class EI-60 (ve i → o) S and EI-120 (ve i → o) S. Declared fire resistance performance for installation in wall, flexible wall and test pressures up to 500 Pa.

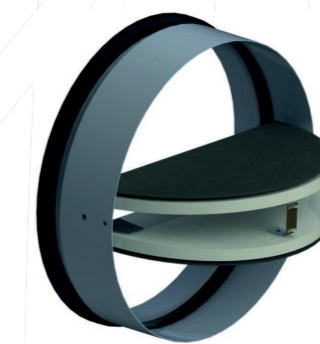

Smoke exhaust dampers

Class EI-120 (ved i ↔ o) S 1500 AA multi. Declared smoke extraction performance for installation in vertical and horizontal duct and test pressures up to 1500 Pa.

